



The XR-EN Installation Manual



APPLICATION

XR luminaires are designed for use in areas subject to extended or continuous submersion requiring IP68. The XR luminaire is also certified for use on marine vessels inside, outside and in other severely wet saltwater environments.

XR luminaires are suitable for use in the following areas as defined by the National Electrical Code (NEC) and the Canadian Electrical Code (CEC):

UL File Numbers: E477827

Standards that apply to all models:

UL 1598, UL 1598A and UL 8750; CSA C22.2 No. 250.0 and CSA C22.2 No. 250.13

Housing: Copper-free Cast Aluminium with Polycarbonate lens

Input Voltage: Based on luminaire suffix in table below:
 Suffix - AC: 120-277 VAC | Suffix - HV: 347-480 VAC

Electrical Ratings:

LUMINANCE	INPUT VOLTAGE	RATED WATTAGE [Watts]	RATED VOLTAGE [Volts]	FREQUENCY [Hz]
XR8	AC	60	120-277	50/60
	HV	64	347-480	50/60
XR10	AC	75	120-277	50/60
	HV	77	347-480	50/60
XR15	AC	103	120-277	50/60
	HV	107	347-480	50/60
XR20	AC	156	120-277	50/60
	HV	160	347-480	50/60

Inrush Current: XR (AC): 65A peak, 1.2ms duration
 XR (HV): 65A peak, 1.2ms duration

APPLICATION Cont.

Ambient Temperature Range:

LUMINANCE	Temp Range General Location (Deg C)
XR8	-50 to 75
XR10	-50 to 74
XR15	-50 to 74
XR20	-50 to 67

Connections: Standard 10ft 18/3 SOOW
 Dimming 10ft 18/5 SOOW
 Refer to wiring diagrams for connections. Class 1 Wiring only.
 All supply field wiring must be rated 300V minimum for luminaires with suffix AC,
 600V minimum for luminaires with suffix HV.

Ingress Protection: IP68 Continuous Submersion 25ft | Suitable for Wet Locations. | Marine Outside Type (Salt Water)



WARNING / ATTENTION

To avoid the risk of fire, explosion, or electric shock, this product should be installed, inspected, and maintained by a qualified electrician only, in accordance with all applicable electrical codes.

Éviter tout risque d'incendie, d'explosion ou d'électrocution, ce produit doit être installé, inspecté et entretenu par un électricien qualifié uniquement, conformément à tous codes électriques applicables.



WARNING / ATTENTION

To reduce the risk of electric shock, disconnect the luminaire from the supply circuit before opening for installation and servicing. Keep tightly closed when in operation.

Pour réduire le risque de choc électrique, débranchez le luminaire du circuit d'alimentation avant l'ouverture pour l'installation et entretien. Gardez hermétiquement fermé pendant le fonctionnement.



WARNING ATTENTION

Potential Electrostatic Charging Hazard
 Risque potentiel de charge électrostatique

Avoid electrostatic discharge:

- Clean exterior lens surface with damp cloth only
- Éviter les décharges électrostatiques: nettoyer la surface extérieure de la lentille uniquement avec un chiffon humide

XR-SM – SURFACE/CEILING MOUNT INSTALLATION

Refer to alternate instructions if using Hook or Yoke Mount

STEP 1.

Inspect shipping package and contents to ensure no damage has occurred during shipping.

STEP 2.

Install Surface/Suspension Mount Brackets using the 8x M6 hex cap bracket mounting screws. See diagram for orientation of brackets. Torque M6 bolts to 5 Nm (45 in-lbs).



STEP 3.

A) For surface mounting configuration, mount luminaire in desired locations using 4x 1/4-20 OR 4x M6 fasteners and washers (Not provided). One mounting hole on each bracket is keyed to allow partial pre-installation of two fasteners for ease of install.

B) For ceiling mounting configurations, connect 4x anchors to the 12.7mm (0.5") holes. Suspension hardware (Not provided) must be rated for a minimum of 180 lbs.

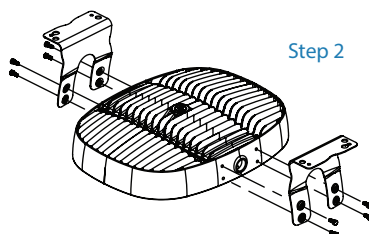

STEP 4.

Terminate the supply end in a suitable listed junction box using a suitable listed fitting approved for installation location as required.

All field wiring supply conductors shall be rated 90°C minimum and rated for supply voltage (300V AC Models, 600V HV models).



Black: Line 1 (L1) | White: Neutral/Line 2 | Green: Ground

Dimming (Flying lead cable):



Black: Line | White: Neutral/Line 2 | Green: Ground
 Red: Dimming (+) | Orange: Dimming

- LED Drivers will source a combined maximum of 200µA for control needs
- 0-10V Controller must sink current from LED driver 0-10V control connections

Connect the lead wires from the cord to the field supply wiring inside the outlet box. The field wiring terminations are to be made following acceptable practices as outlined by the NEC / CEC

STEP 5:

Energize luminaire.

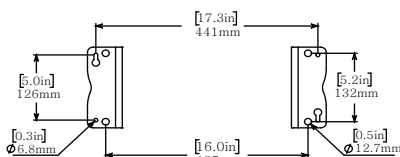

Step 3A

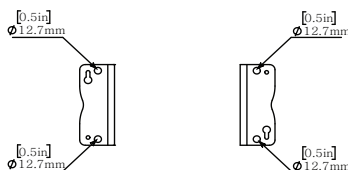

Step 3B

Step 5

XR-YK – HIGH VIBRATION YOKE INSTALLATION

Refer to alternate instructions if using Hook or Yoke Mount

This XR-YK kit is intended for use with UL Listed XR luminaire as marked on the luminaire nameplate.

Accessory Package Contents

XR-YK	QTY	PART NAME
	1	XR HIGH VIBRATION YOKE
	2	CHEEK PLATE
	8	M6 x 1 x 25mm SOCKET FLAT HEAD CAP SCREW
	4	M6 FLAT WASHER
	4	M6 x 1 x 16mm SOCKET HEAD CAP SCREW



STEP 1.

Inspect shipping package and contents to ensure no damage has occurred during shipping.

STEP 2.

Mount XR high vibration yoke to mounting surface using a minimum of 4x ¼-20 or M6 fasteners (not provided).

STEP 3.

Mount XR Cheek Plates to sides of XR luminaire using 4x M6 flat head cap screws per side. Thread one cheek plate over installed wiring during assembly. Torque fasteners to 5 Nm (45 in-lbs).

STEP 4.

Thread installed wiring through opening in XR high vibration yoke mount and install XR luminaire into yoke. The raised circular bosses on the XR cheek plates should register inside of the large circular holes on the XR high vibration yoke mount arms. Rotate luminaire to aim in the desired direction and fasten in place using 2x M6 socket head cap screws and flat washers per side. Torque fasteners to 5 Nm (45 in-lbs).

STEP 5.

Resume installation instructions provided with luminaire (STEP 4 on PAGE 3).

Step 2

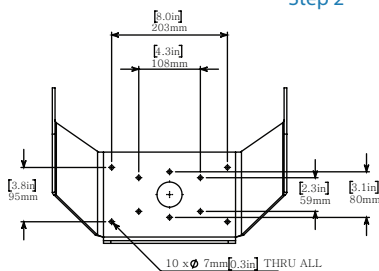

Step 4

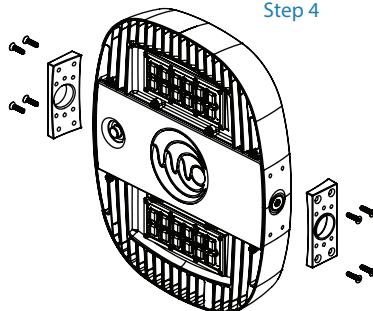

XR-YM – YOKE MOUNT INSTALLATION

Refer to alternate instructions if using Hook or High Vibration Yoke Mount

This XR-YM kit is intended for use with UL Listed XR luminaire as marked on the luminaire nameplate.

Accessory Package Contents

XR-YM	QTY	PART NAME
	1	YOKE MOUNT A
	1	YOKE MOUNT B
	1	CHEEK PLATE
	4	1/4-20 HEX NUT
	4	1/4" FLAT WASHER
	4	1/4-20 x 0.5in CARRIAGE BOLT
	4	M6 x 25mm HEX HEAD CAP SCREW



STEP 1.

Inspect shipping package and contents to ensure no damage has occurred during shipping.

STEP 2.

Loosely assemble Yoke mount with carriage bolts on inside and washers and nuts on the outside.

NOTE: Depending on which mounting hole is used in the curved slot, the luminaire may be configured for an upward or downward adjustable swing.

STEP 3.

Thread installed wiring through openings in yoke mount cheek plate and yoke mount bracket. Mount yoke assembly to luminaire using 4x M6 Socket Head Cap Screws and Washers (Provided). Torque fasteners to 5 Nm (45 in-lbs).

STEP 4.

Mount luminaire assembly to desired location using 4x 1/4-20 OR M6 Screws or Bolts (Not Provided).

STEP 5.

Adjust and aim luminaire to desired position. Torque hardware nuts to 9 N-m (80 in-lbs).

STEP 6.

Resume installation instructions provided with luminaire (STEP 4 on PAGE 3).

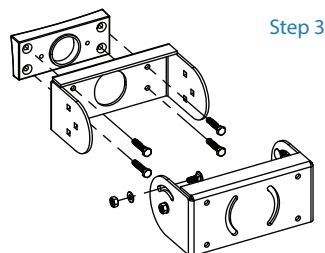

Step 3

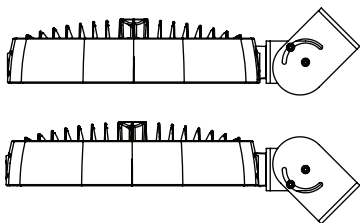

Step 5

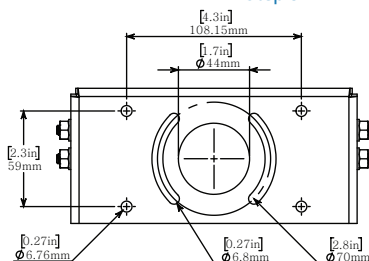

XR-HK – HOOK PENDANT INSTALLATION

Refer to alternate instructions if using Yoke Mount

STEP 1.

Inspect shipping package and contents to ensure no damage has occurred during shipping.

STEP 2.

It is recommended to install Secondary Safety Cable by looping appropriate steel cable or chain through the outer band of the unit and fastening a closed loop. Secondary safety hardware must be rated for a minimum of 110lbs. Secondary safety cables made from stainless steel aircraft cable are available upon request.

STEP 3.

Latch hook onto eye-bolt or other fixed mounting loop. Mounting point must be rated for a minimum of 110lbs.

STEP 4.

Install remaining loop of secondary safety chain or steel cable to suitable mounting location and fasten securely.

STEP 5.

Resume installation instructions provided with luminaire (STEP 4 on PAGE 3).

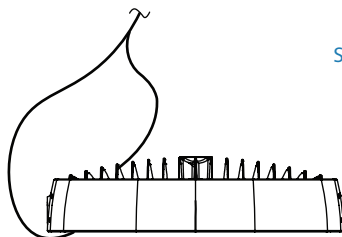

Step 2

XR-SK-## – SECONDARY SAFETY KIT (Ordered Separately)

This XR-SK-## kit is intended for use with UL Listed XR luminaire as marked on the luminaire nameplate.

Accessory Package Contents

XR-SK-##	QTY	PART NAME
	1	1003-01-02-301 (ZLM Secondary Safety)
	1	M6 Flat Washer
	1	M6 x 20mm Hex Cap Screw
	2	Oval Shaped Threaded Connecting Link
	1	Stainless Steel Chain, 1/8" Trade Size

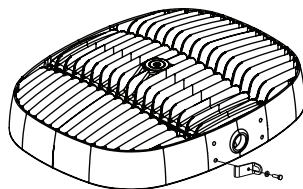

STEP 1.

Remove the bottom-left pre-installed M6 x 16mm Hex Cap Screw.

STEP 2.

Install bracket on XR luminaire as shown using supplied M6 x 20mm Hex Cap Screw. Torque M6 x 20mm Hex Cap Screw to 40 in-lbs (4.5 Nm). It is strongly recommended that a medium or high strength thread-locker be used when installing the bracket. For units using surface or suspension mounting, install safety kit hardware on top of the surface mount or suspension mount brackets in the same location as shown.

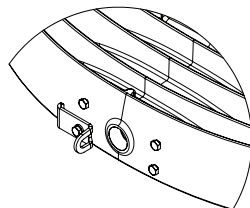

Step 1

STEP 3.

Attach stainless steel chain to safety kit bracket using stainless steel oval shaped threaded connecting link.

STEP 4.

Attach loose end of chain. Secondary safety mounting point must be suitable for supporting a minimum of 120lbs:

- Attach loose end of stainless steel chain to fixed eye-bolt (not supplied) using the second stainless steel oval shaped threaded connecting link.
- Alternate attachment method: Wrap loose end of chain around fixed beam or other immovable support and create a closed loop using the second stainless steel oval shaped threaded connecting link. Supporting beam or structure must form a closed loop to prevent the secondary safety chain from slipping off or becoming unhooked.

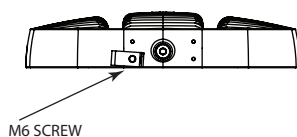

Step 2

